

# WIFI

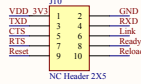

# RS232

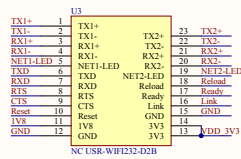
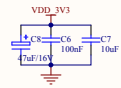
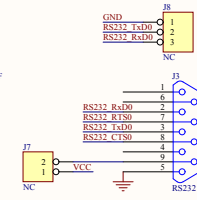
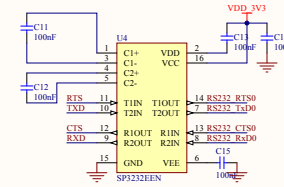

# POWER

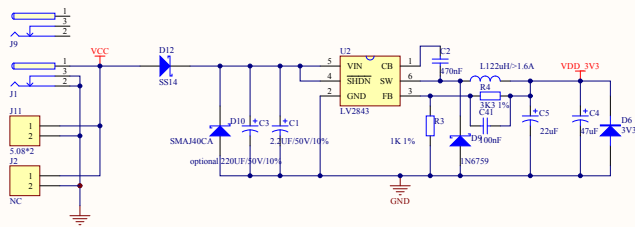

# RS485

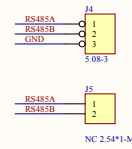
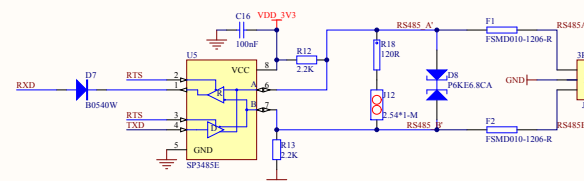

# KEY&LED

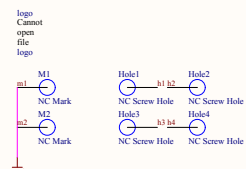
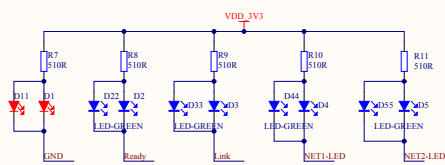
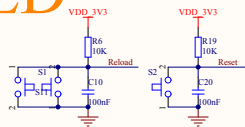

# RJ45

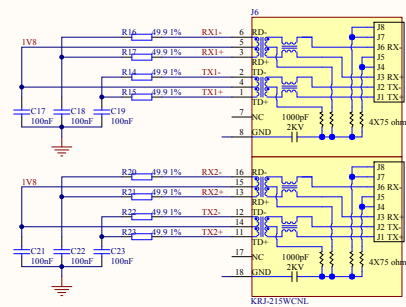

Title		
Size	Number	Revision
C		
Date:	2015-4-8	Sheet of
File:	E:\USR-WIFI	\_USR-WIFI1232-02B\wifidoc